

HOME [premium
wooden furniture



ease for 
luxury life...

COLUXURE



brand close-up...



Coluxure is a Premium Wooden Furniture Mfg. brand by **E-Plast Industries LLP**, Ahmedabad. E-Plast Industries LLP was founded in the year 2011 by Mr. Mohan Varsani and the company is now a key player in the fabrication and furniture industry.

At Coluxure we aim to manufacture and promote good customized designs, which include comfort, strength, durability, visual satisfaction, functional & structural logic. Our catalog offers a wide range of sizes and material options. We can customize our designs to meet specific requirements or work with architects and interior designers to develop furniture for a specific project.

We use high-quality hardware & Material source from reputed manufacturers. Our comprehensive and innovative range of designs and production capability can meet the furniture requirements for varied types and scales of projects from Homes Including Modular Kitchens and Offices to Schools, Colleges, Hotels, and Public Institutions.

Our Strength

We have a well-equipped facility of the latest German machines like Panel Saw, Post form, Spindle Molder, Through Feed & CNC Machine for Modular Furniture in our 20,000 Sq. Ft. Workshop with a team of 30-40 well trained & skilled craftsmen. Our products are available in our company showroom spread over 4500 sq. ft. at Gota, Ahmedabad. Our real strength is our team, about 75 professionals in our factory and 12 personalities in Sales & other departments, who passionately work for the company to meet our targets.

Material and Technical Specification for Modular Home Furniture

MDF	asis, green, action tessa-17 mm thick and in drawer and wardrobe back 6mm.
Ply	citizen industry iso MR Grade semi water proof 17 mm for home furniture.
Particle board	18 mm thick, action tessa, asis shirdi industry, sai decor.
Adhesive	fevicol, euro, royaltouch d3 grade used.
Hot melt glue	jowat, kelibrate Germany base used for fixing edge bend by through feed edge bender.
Laminate	we calculate rate for matt laminate of sunmica, aicamica, merino, sundek, and, green, antique. (if texture or high gloss laminate used, rate of furniture will be as per different laminate cost).
Glass	4 mm modiguard, asai transparent glass or frosting based.
Edge bend	1mm rehau, German based company.
Hardware	lock, auto hinges, telescopic channel of ebco/enox/rajvansi or equivalent.
Kitchen	for waterproof ply rates will be extra, per s.ft
Basket	we calculated s.s. basket in 202 premium quality nikal plated/if s.s. basket in 304 then rate will be extra.
Channel	used hettich, German based company.
Auto hinges	calculated sober, if soft closed then 350/pc extra.
S.S. basket	nickel coated 202 grade 3-5 mm wire used in making stainless steel basket.
Handle	as per company standard design are available (4",6",8") as per shutter size if customer want different design supplied by own then we deduct the handle amount (60/pc).
Aluminum G handle	in profile, if regular finish is used, then rate of handle profile per running ft. will be extra.
Glass	4 mm modiguard, akai transparent glass or frosting based calculated, on design work rate will be extra as per selection.
Shutter	will be counted in matt finish, if high gloss then 100/s.ft. extra.
Premium accessories	premium kitchen accessories rate will be as per price list (finesse, ebco, enox, hettich, haffale).



ease for
luxury life...

Coluxure®

Modular Furniture



Complete project
in time limit



One
stop solution



Best
after sales service



Why? Coluxure

- Premium quality furniture.
- Made from german technology machine.
- Vast factory of 25000s.ft gives you the best finishing.
- 90% work done in factory 10% assembling on site.
- Save time & money for carpentry work.
- Make your home look elegant on a budget.
- We will plan a budget for your home interiors.
- Stylist and comfortable design concept.
- Modern Style in budget
- We take turnkey projects.



Touch & feel luxurious products
at our 4500s.ft **exclusive showroom.**



Bed Room	01-34
Children Room	35-42
Wardrobe	43
Openable wardrobe Outside	44-45
Sliding wardrobe Outside	46
Dressing Unit Inside View	47
Wardrobe Unit Inside View	48-50
LCD Unit	51-58
Partition & Paneling	59-64
Embossed HDF Board Shades	64
Dining Table	65-71
Chairs	72
Center Table	73-77
Sofa Set	78-88
Book Rack	89
Wall Decor	89
Mattress	90
Study Table	91
Bathroom	92
Safety Door	93
Door Design Inside	95
CNC Design	96
Accessories	97-98
Shoe Rack	99





Bed

Size : 5 x 6, 5.5 x 6, 6 x 6

Type : Box, Hydraulic, Drawer





Wardrob

Size : W53xH75xD21

Sidebox

Size : W16xH16xD18



Dressing

Size : W30xH72xD16





Bed

Size : 5 x 6, 5.5 x 6, 6 x 6
Type : Box, Hydraulic, Drawer





Wardrob

Size : W47xH75xD18



Sidebox

Size : W16xH16xD18





Bed

Size : 5 x 6, 5.5 x 6, 6 x 6
Type : Box, Hydraulic, Drawer





Sidebox

Size : W16xH16xD18



Wardrob

Size : W50xH75xD21





Bed

Size : 5 x 6, 5.5 x 6, 6 x 6
Type : Box, Hydraulic, Drawer





Sidebox

Size : W16xH16xD18



Wardrob

Size : W50xH75xD21





Bed

Size : 5 x 6, 5.5 x 6, 6 x 6

Type : Box, Hydraulic, Drawer



Wardrob

Size : W50xH75xD21



Sidebox

Size : W16xH16xD18







Wardrobe

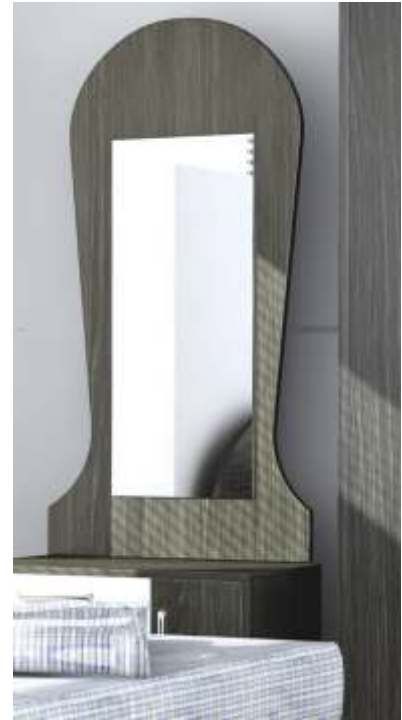

Dressing

Description	Width	Length	Height	Internal Description
Queen Bed	1560	2024	900	2 Side Trolley
King Bed	1864	2024	900	2 Side Trolley
Side Table	735	475	900	2 Drawer Unit (2nos)
Wardrobe Unit	1400	600	2035	3 Door Wardrobe Unit
Dressing Unit	700	450	1828	3 Drawer & 1 Door With Mirror

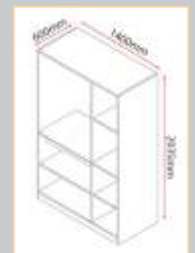
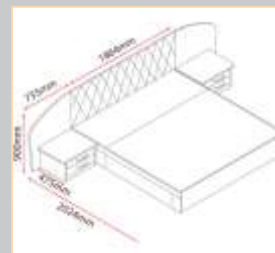

All Material will be in MDF & Visible side in Membrane finish

1) Queen Bed Matters Size	1524 x 1981 (5 Feet x 6.5 Feet)
2) King Bed Matters Size	1828 x 1981 (6 Feet x 6.5 Feet)
PPB : Prelam Particle Board	MDF : Medium Density Fiber-board
PLY : Marine Ply	

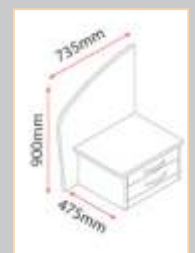

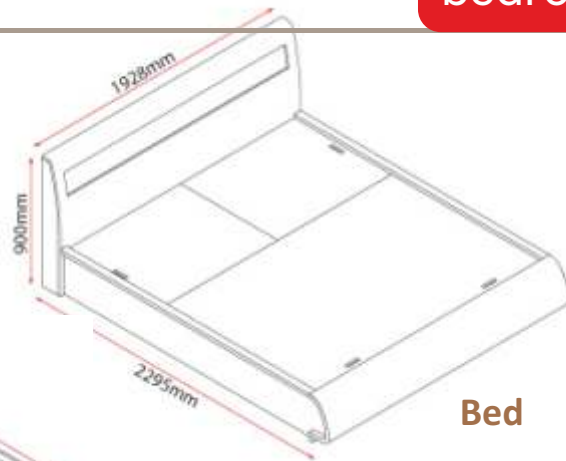

Bed

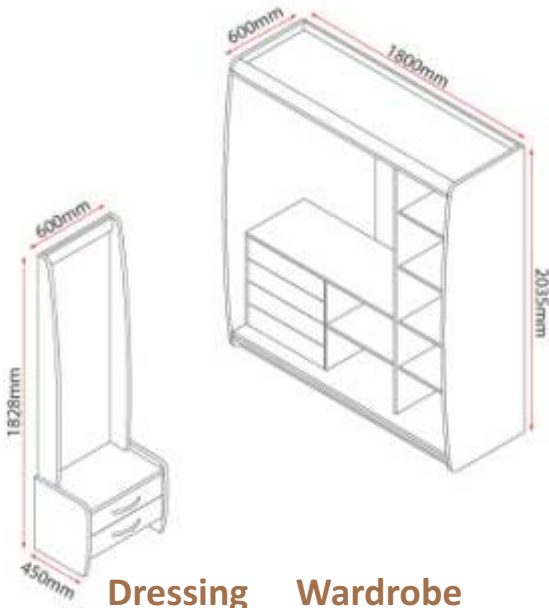

Dressing Wardrobe

Description	Width	Length	Height	Internal Description
Queen Bed	1624	2295	900	Normal Storage, Hydraulic Storage
King Bed	1928	2295	900	Normal Storage, Hydraulic Storage
Side Table	600	490	450	Two Drawer Unit (2Nos)
Wardrobe Unit	1800	600	2035	2 Door Sliding Wardrobe
Dressing Unit	600	450	1828	2 Drawer With Mirror

All Material will be in MDF & Visible side in PU finish

1) Queen Bed Matters Size	1524 x 1981 (5 Feet x 6.5 Feet)
2) King Bed Matters Size	1828 x 1981 (6 Feet x 6.5 Feet)
PPB : Prelam Particle Board	MDF : Medium Density Fiber-board
PLY : Marine Ply	



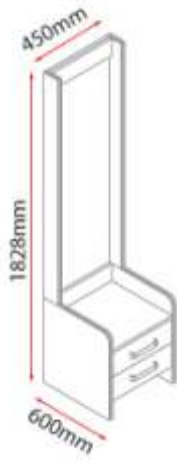

Dressing

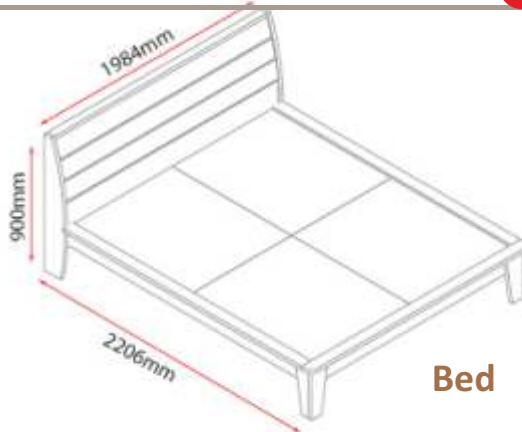

Bed

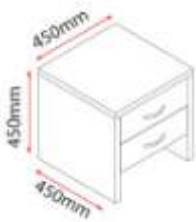

Side Table

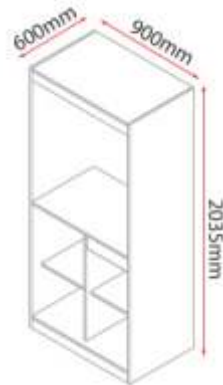

Wardrobe

Description	Width	Length	Height	Internal Description
Queen Bed	1680	2206	900	Without Storage
King Bed	1984	2206	900	Without Storage
Side Table	450	450	450	One Drawer Unit (2nos)
Wardrobe Unit	900	600	2035	2 Door Wardrobe With 1 Internal Drawer & 1 Shelf
Dressing Unit	450	450	1828	2 Drawer & With Mirror

All Material will be in Prelam Particle board or Prelam MDF or Ply + Laminate Finish

1) Queen Bed Matters Size	1524 x 1981 (5 Feet x 6.5 Feet)
2) King Bed Matters Size	1828 x 1981 (6 Feet x 6.5 Feet)
PPB : Prelam Particle Board	MDF : Medium Density Fiber-board
PLY : Marine Ply	





































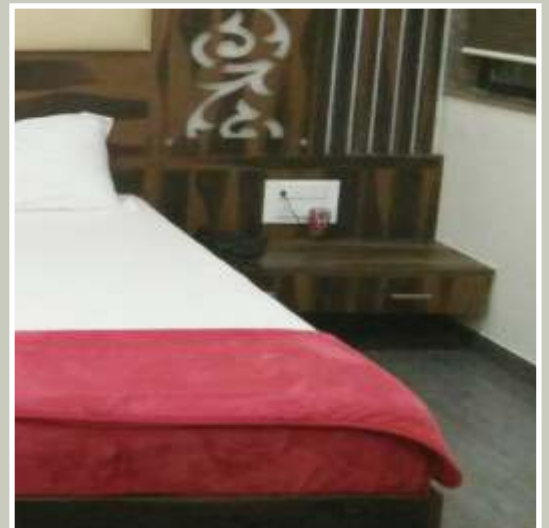





















36-A
Size : W60xH16xD72



36-B
Size : W30xH16xD72



36-C
Size : W60xH16xD72



36-D
Size : W30xH16xD72



CW-1
Size : W36xH72xD21



CW-2
Size : W54xH72xD21



CW-3
Size : W72xH72xD21

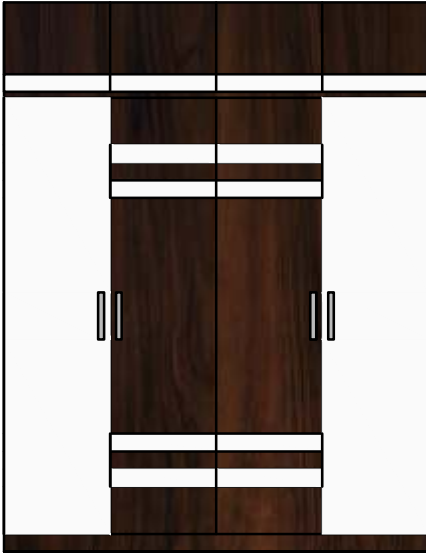

COW-01

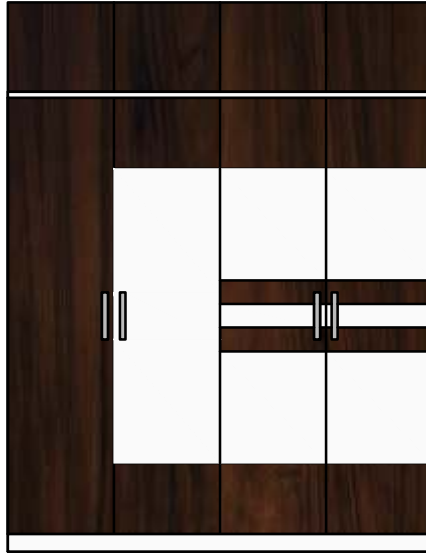

COW-02



COW-03

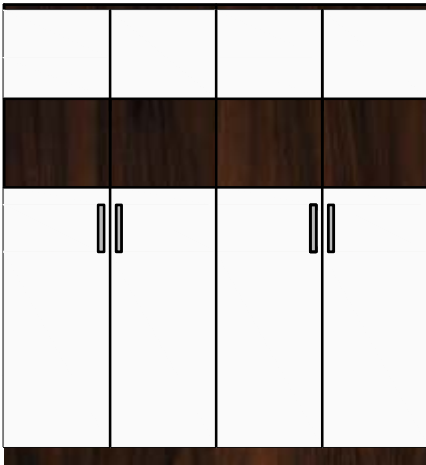

COW-04

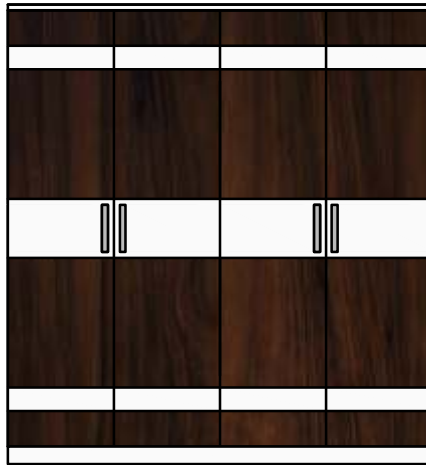

COW-05

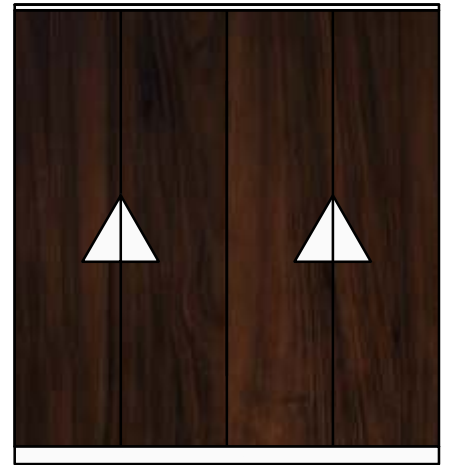

COW-06

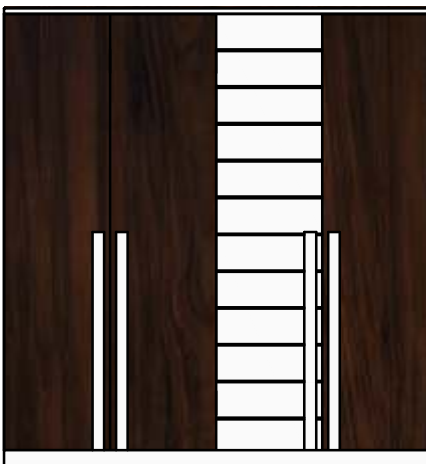

COW-07



COW-08

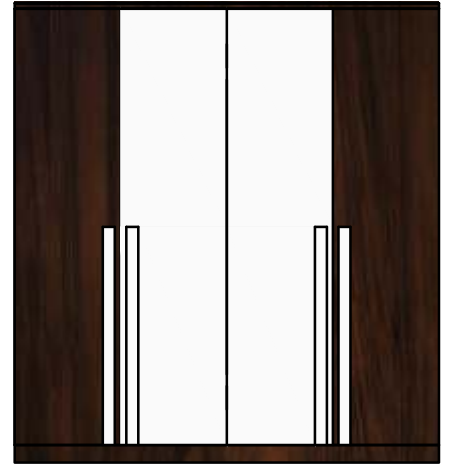

COW-09

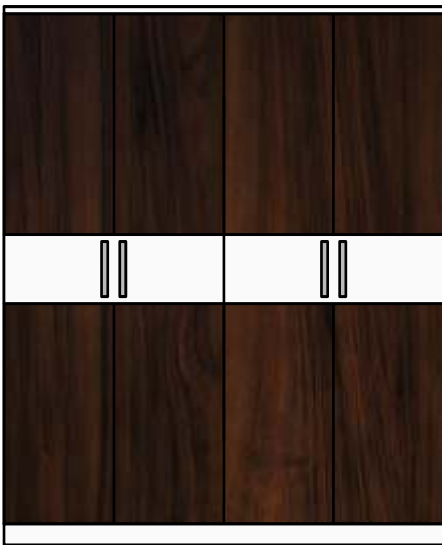

COW-10



COW-11



COW-12

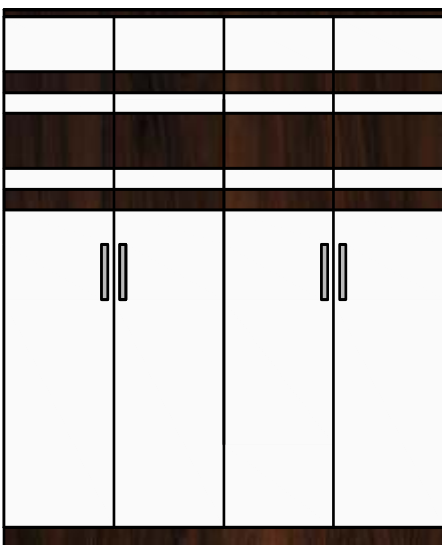

COW-13



COW-14



COW-15



CSW-01



CSW-02

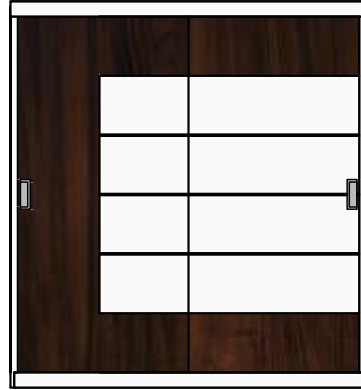

CSW-03

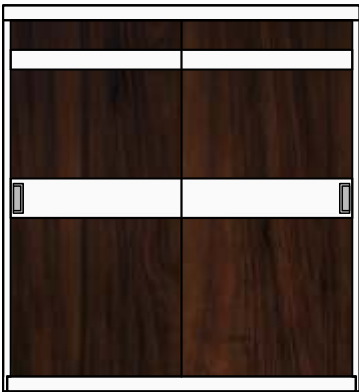

CSW-04



CSW-05



CSW-06

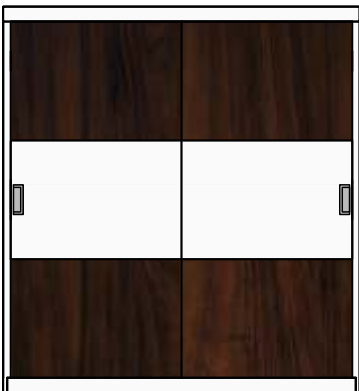

CSW-07

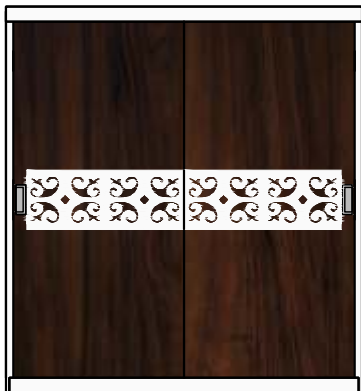

CSW-08



CSW-09



CSW-10

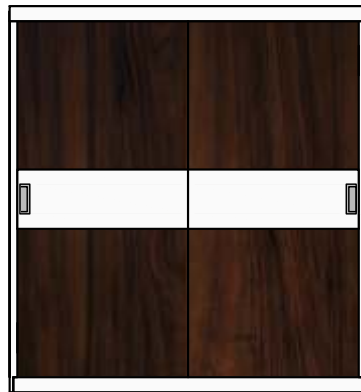

CSW-11

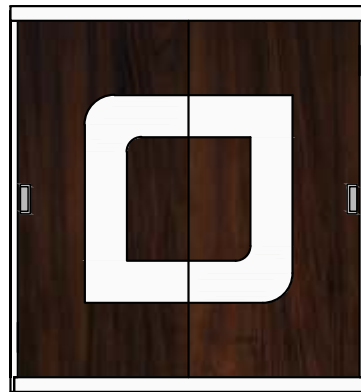

CSW-12

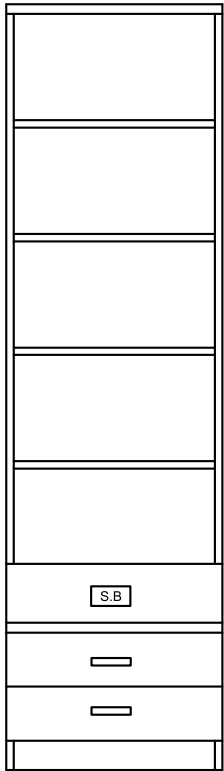

DI-1

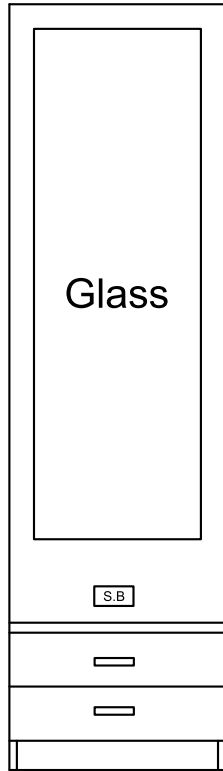

DI-2

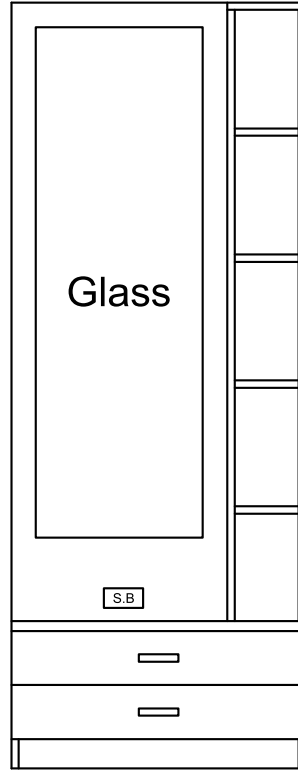

DI-3

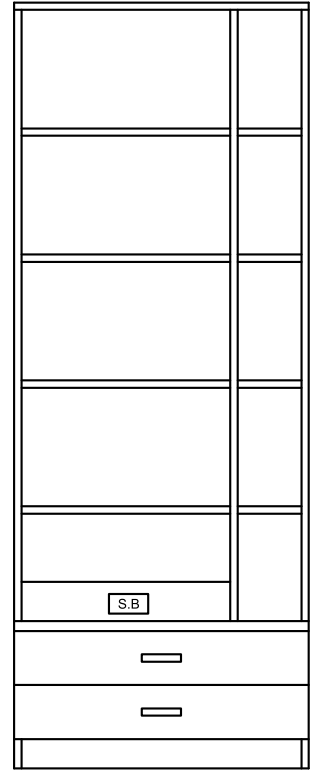

DI-4



1 Door

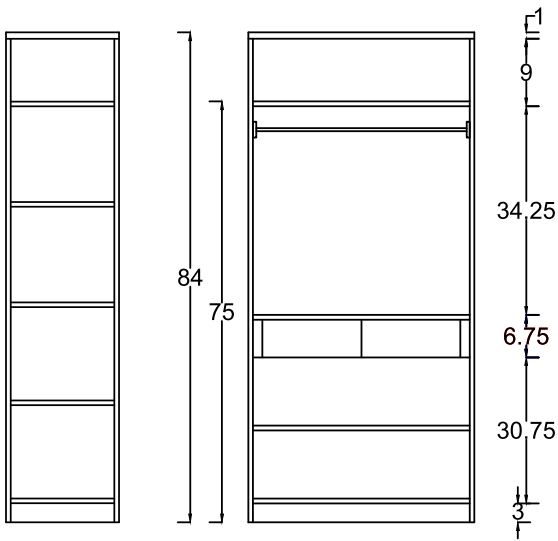

WI-1

WI-2

2 Door

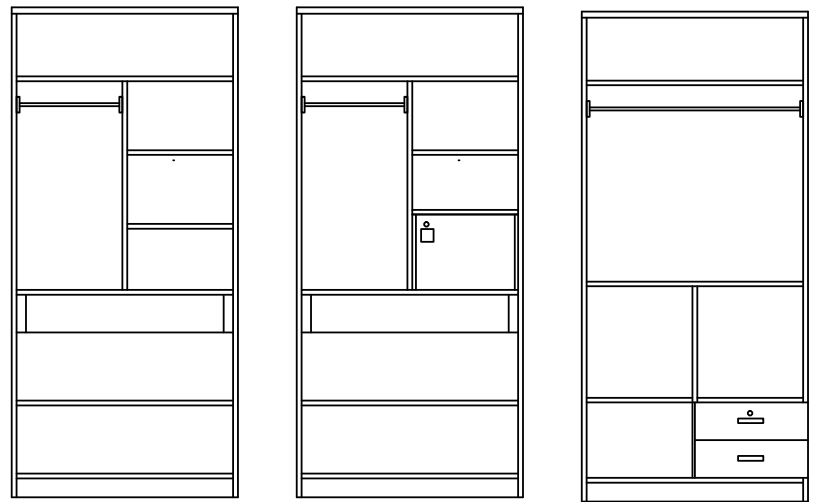

WI-3

WI-4

WI-5

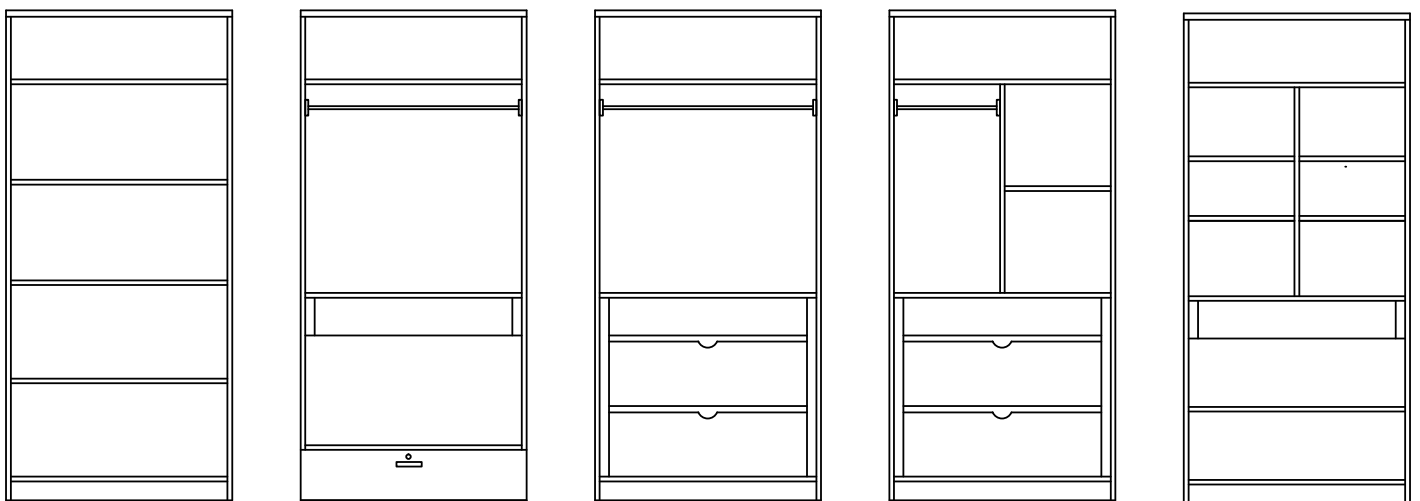

WI-6

WI-7

WI-8

WI-9

WI-10

3 Door

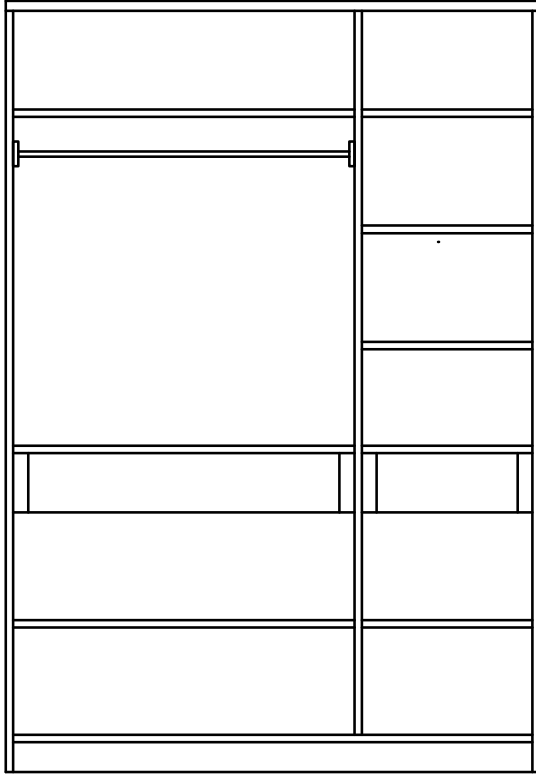

WI-11

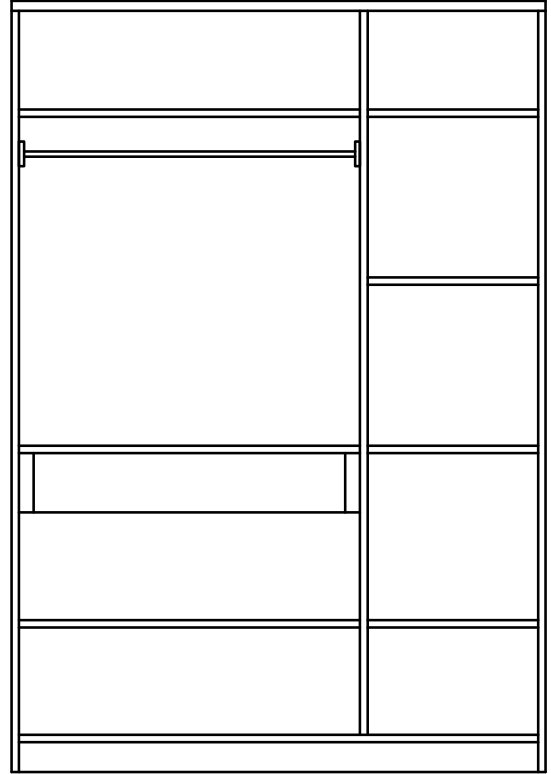

WI-12

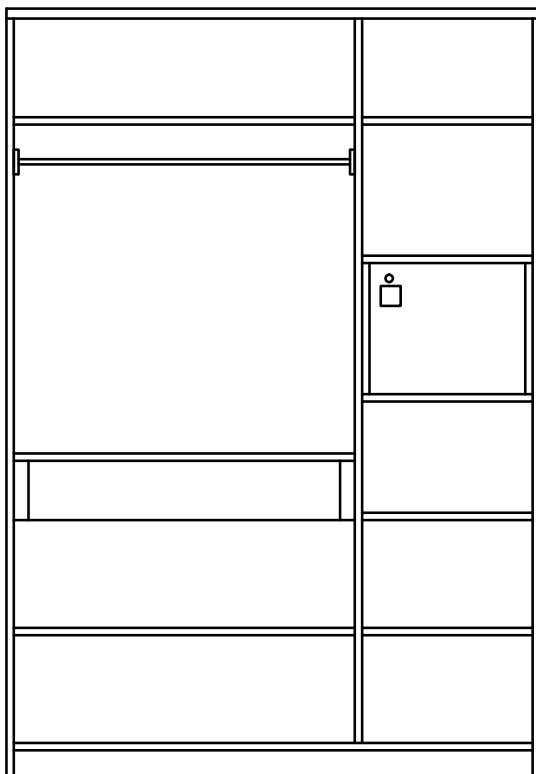

WI-13

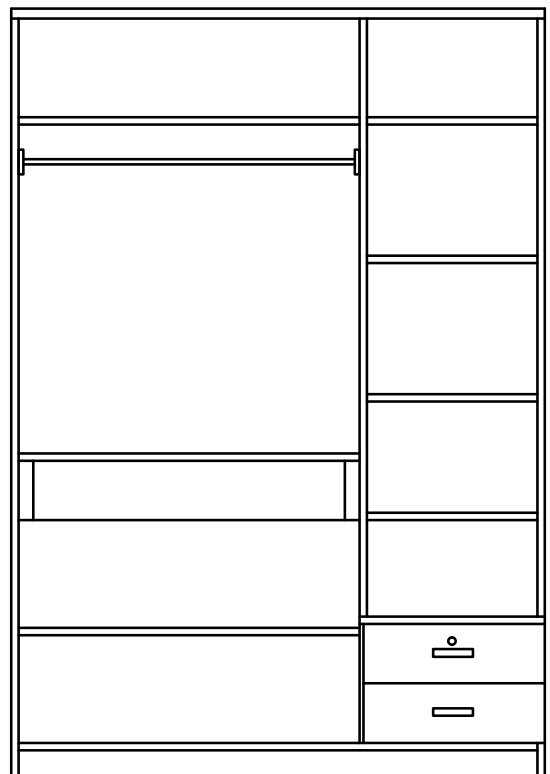

WI-14

4 Door

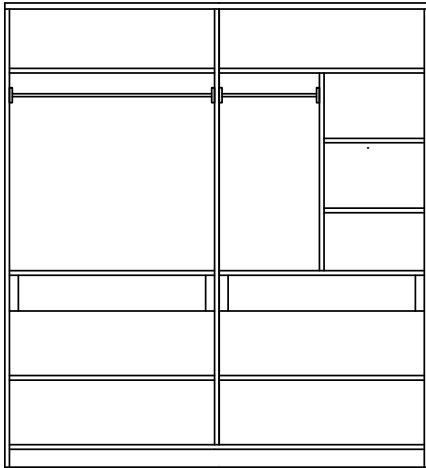

WI-15

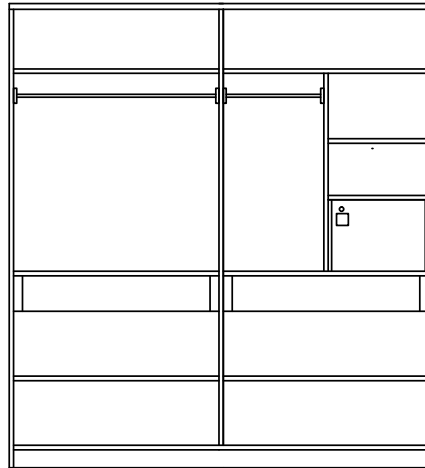

WI-16

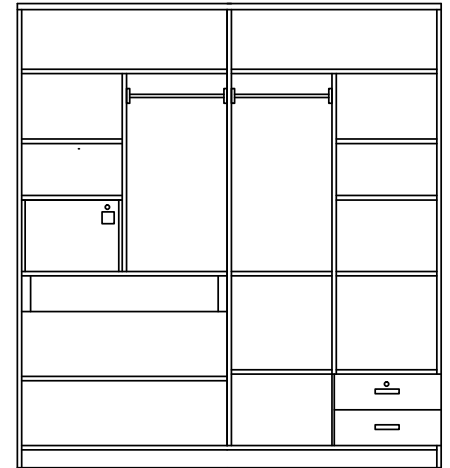

WI-17

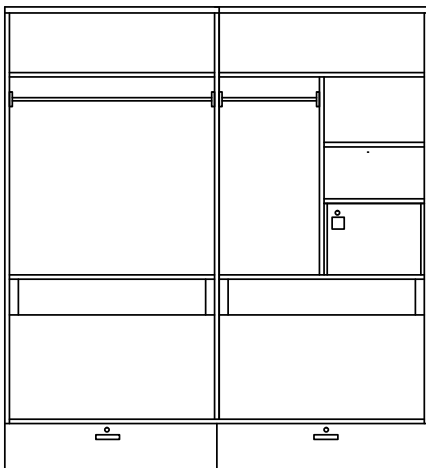

WI-18

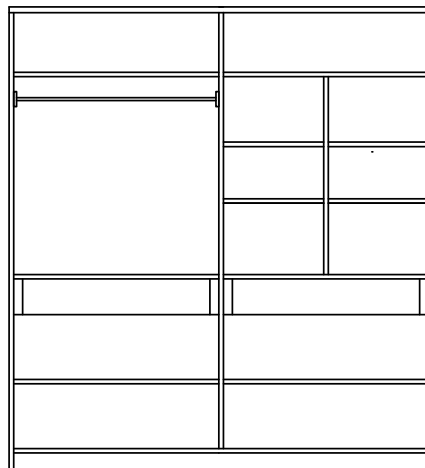

WI-19

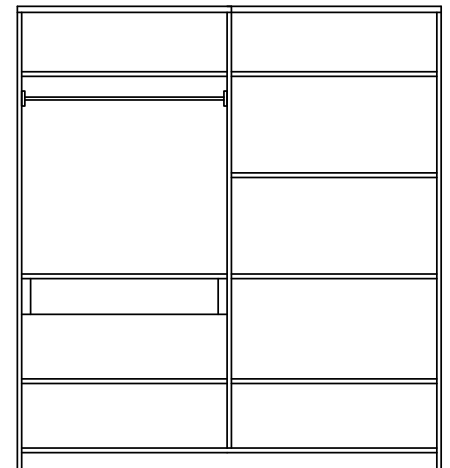

WI-20





CLU-1



CLU-2



CLU-3



CLU-4



CLU-5



CLU-6



CLU-7



CLU-8



CLU-9



CLU-10



CLU-11



CLU-12



CLU-13

CLU-14



LCD -A
Size : W60xH24xD16



LCD -B
Size : W36xH24xD16



LCD -C
Size : W36xH24xD16



LCD -D
Size : W60xH24xD16



LCD -E
Size : W48xH24xD16



LCD -F
Size : W60xH24xD16



LCD -G
Size : W60xH24xD16







CPP-5



CPP-6





CPP-9



CPP-10



CPP-11

embossed HDF board shades

HDF



Leaf



Mats



Plume



Web



Honey Com

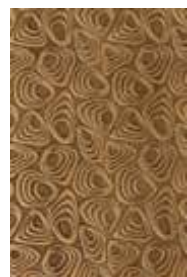

Butterfly



Petal



Fern



Cubold



Bamboo Mat



Fire Works



Flora

Size : W48xH36
W60xH36



DNTB 01



DNTB 02

Size : W48xH36
W60xH36



DNTB 03



DNTB 04

Size : W48xH36
W60xH36



DNTB 05



DNTB 06

Size : W48xH36
W60xH36



DNTB 07



DNTB 08

Size : W48xH36
W60xH36



DNTB 09



DNTB 10

Size : W48xH36
W60xH36



DNTB 11



DNTB 12



DNTB 13



DNTB 14



CHTB 01



CHTB 02



CHTB 03



CHTB 04



CHTB 07



CHTB 08



CHTB 09



CHTB 10



CHTB 11



CHTB 12



CHTB 13



Rocking Chair
Fully Wooden

Size : W48xL24
W36xL24
W30xL21



CTTB 01



CTTB 02



CTTB 03



CTTB 04



CTTB 05



CTTB 06

Size : W48xL24
W36xL24
W30xL21



CTTB 07



CTTB 08



CTTB 09



CTTB 10



CTTB 11



CTTB 12

Size : W48xL24
W36xL24
W30xL21



CTTB 13



CTTB 14



CTTB 15



CTTB 16



TB 4Seat

Size : W48xL24
W36xL24
W30xL21



CTTB 17



CTTB 18



CTTB 19



CTTB 20



CTTB 21



CTTB 22

Size : W48xL24
W36xL24
W30xL21



CTTB 23



CTTB 24



CTTB 25



CTTB 26



CTTB 27



CTTB 28





CS-3



CS-4



CS-5



CS-6



CS-7



CS-8 A



CS-8

CS-8 B



CS-9



CS-10-A



CS-10

CS-10-B



CS-11-A



CS-11-B

CS-11



CS-12





CS-13



CS-14



NS-15-A



NS-15-B



CS-15



NS-16-A



CS-16

NS-16-B





NS-17-A



CS-17



NS-17-B



CS-18



CS-19





CS-20



CS-21





CM-1







CBW 01



CBW 02



CBW 03



CBW 04



CSD-1



CSD-2



CSD-3





CDI-1

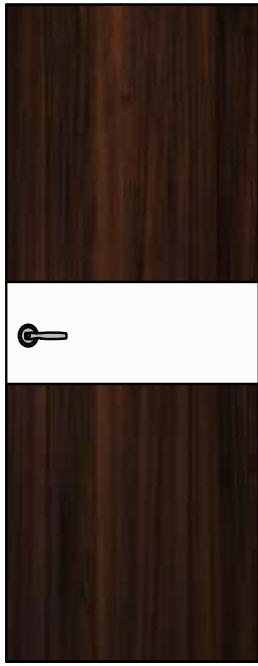

CDI-2

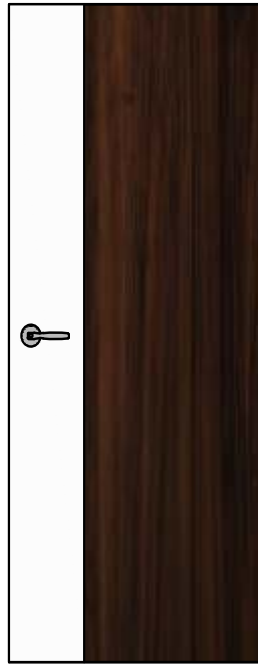

CDI-3

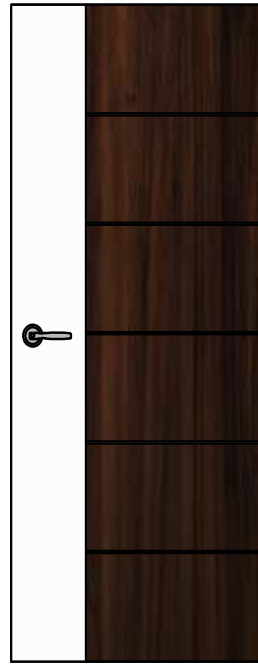

CDI-4

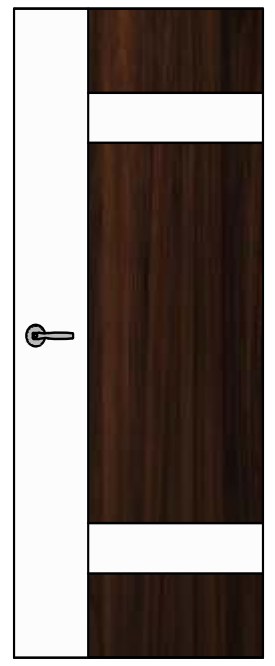

CDI-5

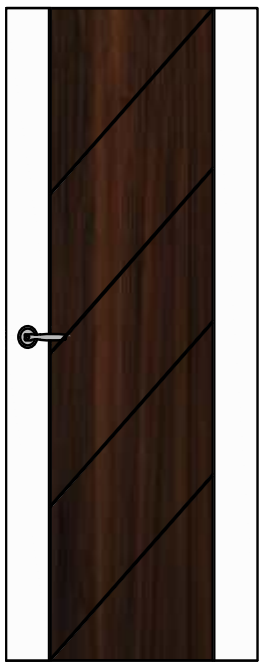

CDI-6

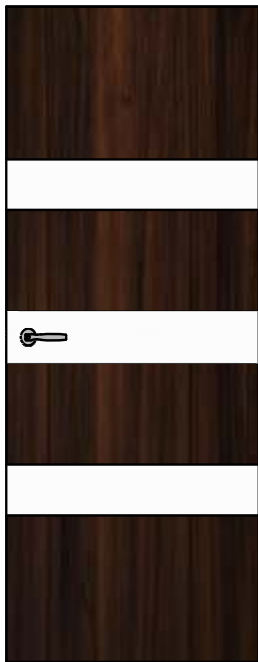

CDI-7

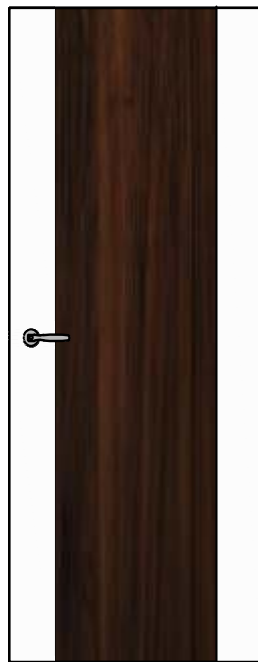

CDI-8

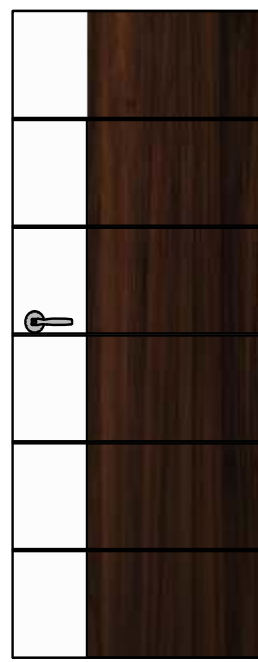

CDI-9

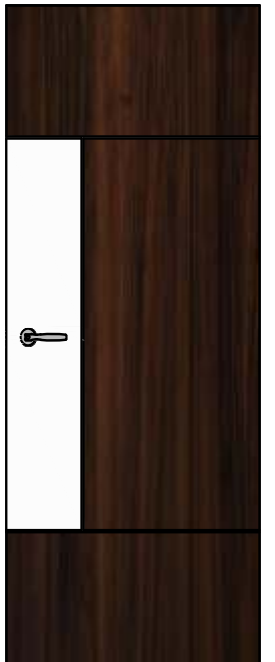

CDI-10



CC-1

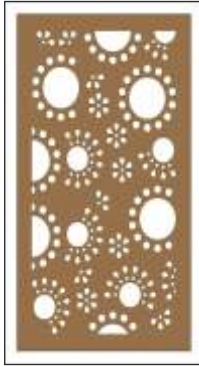

CC-2



CC-3



CC-4



CC-5



CC-6



CC-7



CC-8



CC-9



CC-10

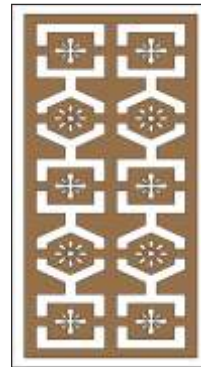

CC-11



CC-12



CC-14



CC-15



CC-16



CC-17



CC-18



CC-19



LG-9039



LG-9040



LG-9043

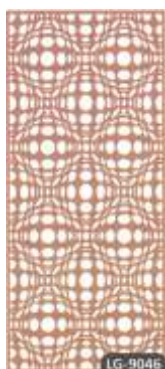

LG-9046



LG-9055



LG-9056



LG-9059



Lock-1



Lock-2



Lock-3



Lock-4



Lock-5



Lock-6



Khiti



Towel Self



Glass Corner



Auto Hanger System



Trousers Hanger



Telescopic Channel



Auto Hinges



Soft Close Hinges



Gas Pump

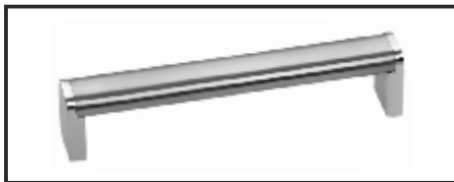

Size : 4" 6" 8" Code :01



Size : 4" 6" 8" Code : 02

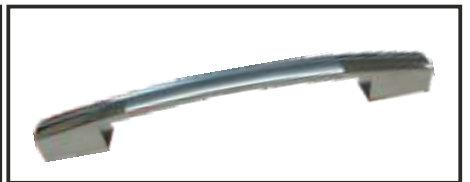

Size : 4" 6" 8" Code : 03

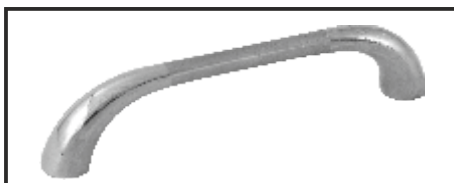

Size : 4" 6" 8" Code : 04



Size : 4" 6" 8" Code : 05



Size : 4" 6" 8" Code : 06

ULTRA THIN WALL MOUNTED SPACE SAVING SHOE RACK

REQUIRES JUST 5.5 INCHES OF YOUR SPACE TO ACCOMMODATE ALL YOUR FAMILY FOOTWEAR

MODELS AVAILABLE



R5

Size : H 67.5" X W 20.5" X D 5.5"
Capacity : Upto 25 Pairs
Colour : Black, Ivory & Box White/self Maroon
Rate : **7700/-**



R4

Size : H 54" X W 20.5" X D 5.5"
Capacity : Upto 20 Pairs
Colour : Black, Ivory & Box White/self Maroon
Rate : **6400/-**



R3

Size : H 41" X W 20.5" X D 5.5"
Capacity : Upto 15 Pairs
Colour : Black, Ivory & Box White/self Maroon
Rate : **5500/-**

JUMBO SERIES



L4

Size : H 54" X W 31" X D 5.5"
Capacity : Upto 36 Pairs
Colour : Black, Ivory & Box White/self Maroon
Rate : **9700/-**



L3

Size : H 41" X W 31" X D 5.5"
Capacity : Upto 27 Pairs
Colour : Black, Ivory & Box White/self Maroon
Rate : **7650/-**



L2

Size : H 29" X W 31" X D 5.5"
Capacity : Upto 18 Pairs
Colour : Black, Ivory & Box White/self Maroon
Rate : **6700/-**

UNIQUE FEATURES

- **Very high and robust quality.** Once placed you can use it for minimum **10 years**.
- Comes with **centralised lock** so you can also place outside your house
- Made of **0.8mm Galvanised Steel**
- Gone through several chemical processes to make it completely **weather resistant**
- All the shelves open at once so you can locate your footwear without wasting your time
- Well ventilated which makes it **clean and hygienic**
- **Comes with lifetime warranty**

OUR CERTIFICATION



WE ARE
ISO 9001:2015, 14001:2015, 45001:2018, 50001:2018
GREENGUARD COMPLIANCE, BIFMA LEVEL 1 2 & 3
CERTIFIED COMPANY
WE WORKS IN A SYSTEMATIC WAY

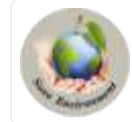

ease for
luxury life...

Coluxure Advantages.



Quick Shipment

Dispatch of products within minimum days of order



Simple to Relocate

Easy portability and convenient to reassemble



Best Prices

Economical and affordable



Contemporary Design

Modern and innovative design that evolves out of your need



Highly Modular

Easily expandable & adjustable.



Sturdy and Solid

A result of high quality raw materials and intelligent engineering



Easy Installation

Quickest modular furniture to install



Flexible Form

Change, rearrange, recreate your home space, as you wish



Best Investment

Best value for your money



Wire Management

built in electrical and wiring solutions



SOME OF OUR CLIENTS





Kitchen Furniture Catalog



Office Furniture Catalog



Home Furniture Catalog



Institute Furniture Catalog

— WE BELONGS TO **KAKA GROUP OF COMPANY** —





Showroom
Eplast Industries LLP
Coluxure Modular Furniture
Verai Estate, Before Gota Muktidham AMC,
Gota- Jagatpur Road, Gota, Ahmedabad - 382481
GUJARAT, INDIA.



 sales@eplast.in
 www.eplast.in



GO TO WEBSITE



ADD CONTACT

FOR INQUIRY CALL US

(O) +91 99747 00352 (M) +91 98985 00475



Showroom Location